

DONN® DXM OMEGA

Seismic rated, fastest installation and removal without tools

Features and benefits

- * Patented QRC (Quick Release Clips) are easy to remove without tools, fast to install, ensure grid module squareness and firmness.
- * Cross tee with override-ends resists twisting and give a professional finished look with no exposed steel edges.
- * Hot dipped steel galvanization coating system on grid components resist corrosion and rust.
- * Superior modified polyester paint finishing.
- * The aesthetic of more expensive bolt-slot grid with the function and utility of expose grid.
- * Unique, narrow 14mm profile slotted grid with rounded 1/8" (3mm) reveal softens the effect of grid lines to enhance the finished look.
- * A comprehensive range of USG acoustical panels are available to complement the system.
- * Available in 2'x2', 2'x4', 600x600mm and 600x1200mm module.
- * Comply with ASTM C 635 and ASTM E580 standards.

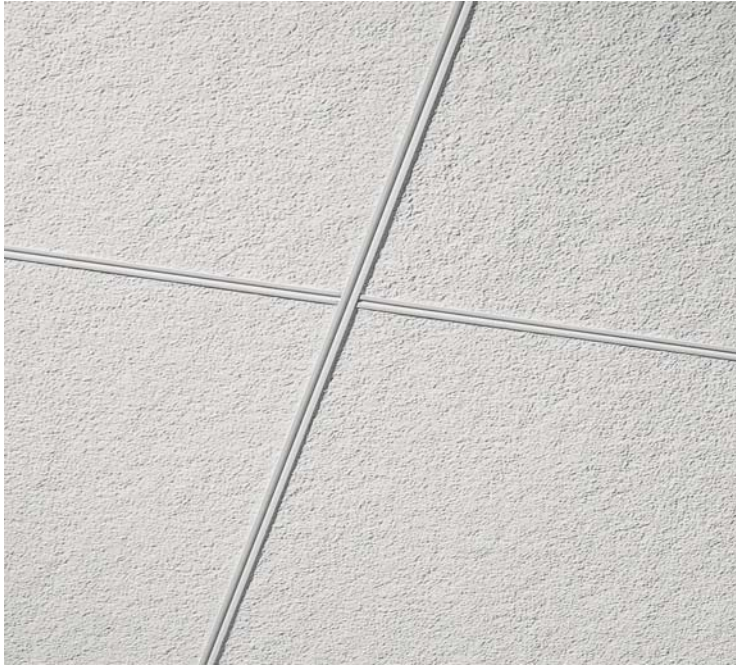

1.

This improved front edge detail reduces the force you need to insert the tee so you can install with less effort but without compromising stability. It also allows installation from top, level and below the grid. Ideal in tight or cramped conditions.

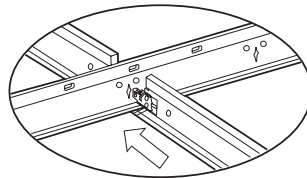
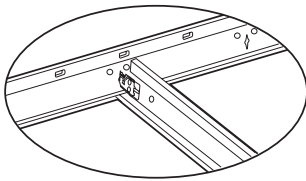

3.

The unique profiled flag shape gives a loud click on insertion and is designed to prevent snagging on the main tee web. So installer can count on the clip being positively located.

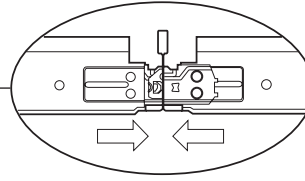

4.

High clip-to-clip locking tolerance produces one of the strongest and tightest tee / tee connections ever keeps the whole system straight and square.

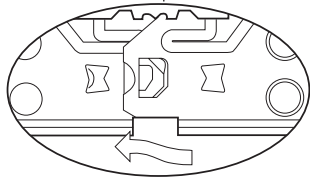

2.

The top notch helps to closely capture the main tee web for improved system tightness and allows cross tees to cantilever to prevent grid drop during installation.

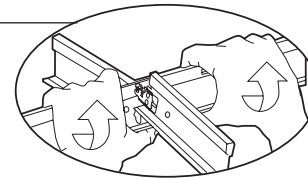
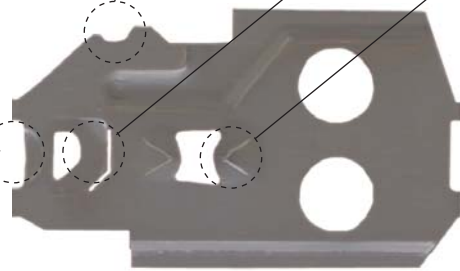

5.

Patented clip design- just twist and the tees are released. No tools needed.

1. Easier installation

DONN® DXM Omega leads the industry with up to 40% less insertion force required. This decreases the amount of installation work and saves you time.

2. Consistent insertion force

The DONN® DXM Omega cross tee insertion force variation is only ± 2 lbs., thus it allows for repetitive, predictable and faster installation. Installer does not have to struggle with installation.

3. Easier removal without tools

When it comes to changes or errors during installation, the DONN® DXM Omega cross tees can be easily removed by rotating or twisting the cross tee / main tee intersection.

4. Multiple cross tee installation angles

The DONN® DXM Omega cross tee can be installed speedily from top, level and below in areas with low plenum, or with plenum obstructions and varying ceiling heights.

5. Seismic rating

In compliance with ASTM E 580 4.1.2

6. Tight and square grid modules

The DONN® DXM Omega patented clip design provides close locking tolerance for tight module control and clean square lines. This is ideal for large or small ceiling areas.

7. Faster installation

The unique profiled flag shape gives a loud click on insertion, so installer can count on the clip being positively located.

8. Cross tee cantilever

The patented top notch safety design helps to closely capture the main tee web for improved system tightness and allows cross tees to cantilever to prevent grid drop during installation.

9. Cross tee clip-to-clip locking tolerance

The new improved high tolerance clip-to-clip locking design produces strongest and tightest tee / tee connections ever, with pull out strength of more than 300 lbs. This feature will ensure the whole system is straight and square.



Product Component	Unit	Item Code No.	Length mm / ft	Height mm	Width mm	Thickness mm	Packaging Quantity / carton
Main Tee	Metric	DXM OG 3000 IM	3000	32	14	0.30	40
	Imperial	DXM OG 3048 IM	10'	32	14	0.30	40
Cross Tee	Metric	DXM OG 1200 IM	1200	32	14	0.30	80
	Imperial	DXM OG 1220 IM	4'	32	14	0.30	80
	Metric	DXM OG 600 IMM	600	32	14	0.30	120
	Imperial	DXM OG 610 IMM	2'	32	14	0.30	120
Wall angle	Metric	NTA 3000	3000	-	22 x 14	0.45	50

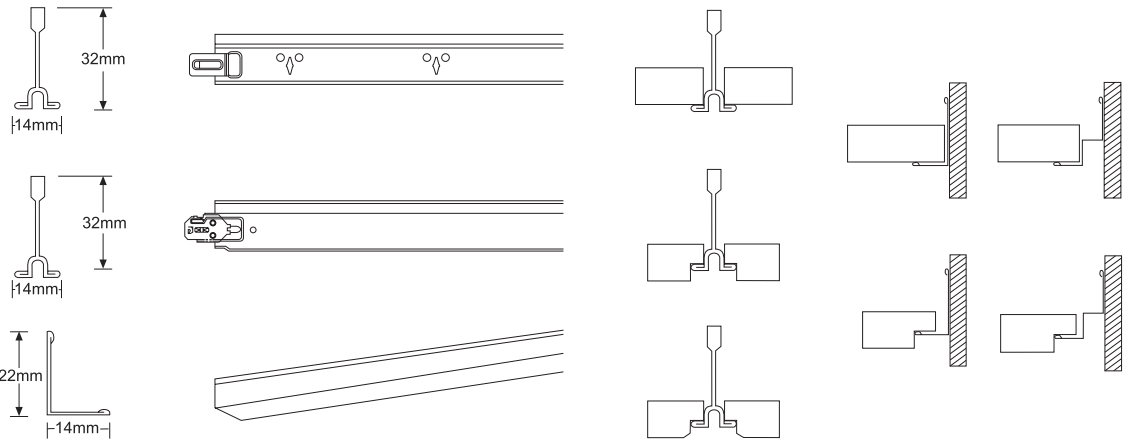

Uniform Loads-kg/lm (linear metre)

DONN® DXM Omega component	Uniform Load kg/lm
Main tee DXM Omega 3000 IM @ 1.2m centres	9.7
Cross tee DXM Omega 1200 LM	11.9

Load test data shows uniform load in kg/lm based on simple span test in accordance with ASTM C 635 deflection limit on L/360